

Parameter	Rating	Units
Breakdown Voltage BV_{CEO}	30	V_P
Current Transfer Ratio (Typical)	300	%
Saturation Voltage	0.5	V
Input Control Current	1	mA

Features

- Small 6-Pin Package, Thru-Hole or Surface Mount
- Low Drive Power Requirements (TTL/CMOS Compatible)
- No Moving Parts
- High Reliability
- Arc-Free With No Snubbing Circuits
- 3750V_{rms} Input/Output Isolation
- No EMI/RFI Generation
- Machine Insertable, Wave Solderable
- Surface Mount Tape & Reel Version Available

Applications

- Telecom Switching
- Tip/Ring Circuits
- Modem Switching (Laptop, Notebook, Pocket Size)
- Loop Detect
- Ringing Detect
- Current Sensing

Description

The LDA100 is a bidirectional-input optocoupler with a single transistor output. Optically coupled technology provides a 3750V_{rms} isolation barrier between the input and the output.

Approvals

- UL Recognized Component: File # E76270
- CSA Certified Component: Certificate # 1175739

Ordering Information

Part Number	Description
LDA100	6-Pin DIP (50/Tube)
LDA100S	6-Pin Surface Mount (50/Tube)
LDA100STR	6-Pin Surface Mount (1000/Reel)

Pin Configuration

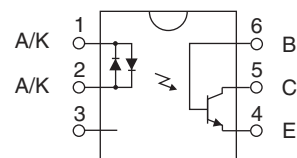

Absolute Maximum Ratings

Parameter	Ratings	Units
Breakdown Voltage	30	V _P
Input Control Current	50	mA
Peak (10ms)	1	A
Power Dissipation		
Input ¹	150	mW
Phototransistors ²	150	
Isolation Voltage Input to Output	3750	V _{rms}
Operational Temperature	-40 to +85	°C
Storage Temperature	-40 to +125	°C

¹ Derate Linearly 1.33 mW/°C
² Derate Linearly 2.0 mW/°C

Electrical absolute maximum ratings are at 25°C

Absolute Maximum Ratings are stress ratings. Stresses in excess of these ratings can cause permanent damage to the device. Functional operation of the device at conditions beyond those indicated in the operational sections of this data sheet is not implied.

Electrical Characteristics

Parameters	Conditions	Symbol	Min	Typ	Max	Units
Output Characteristics @ 25°C (unless otherwise noted)						
Phototransistor Breakdown Voltage	I _C =10μA	BV _{CEO}	30	85	-	V
Phototransistor Dark Current	V _{CE} =5V, I _F =0mA	I _{CEO}	-	-	500	nA
Saturation Voltage	I _C =2mA, I _F =1mA	V _{CE(sat)}	-	-	0.5	V
Current Transfer Ratio	I _F =1mA, V _{CE} =0.5V	CTR	33	300	-	%
Output Capacitance	25V, f=1MHz	C _{OUT}	-	6	-	pF
Input Characteristics @ 25°C						
Input Control Current	I _C =0.33mA, V _{CE} =0.5V	I _F	-	-	1	mA
Input Voltage Drop	I _F =5mA	V _F	0.9	1.2	1.4	V
Common Characteristics @ 25°C						
Input to Output Capacitance	-	C _{I/O}	-	3	-	pF

Switching Characteristics @ 25°C

Characteristic	Symbol	Test Condition	Typ	Units
Turn-On Time	t _{ON}	V _{CC} =5V, I _F =2mA, R _L =1KΩ	7	μs
Turn-Off Time	t _{OFF}		20	

Switching Time Test Circuit

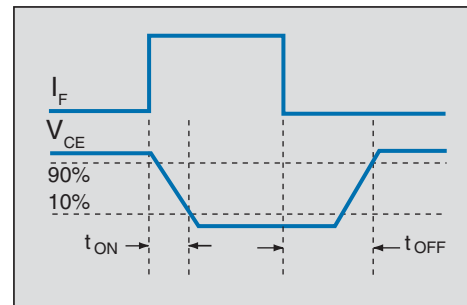
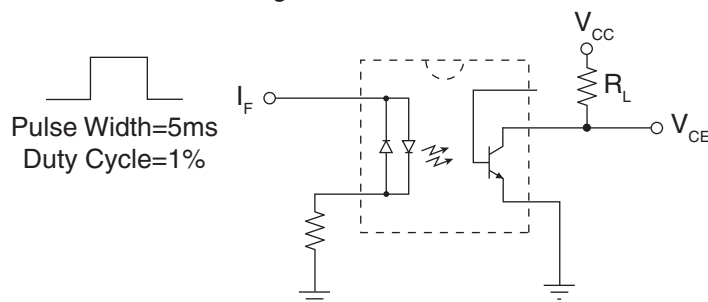

PERFORMANCE DATA*

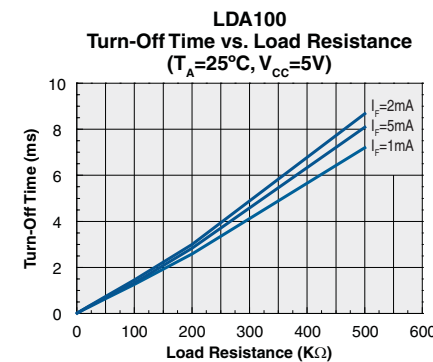
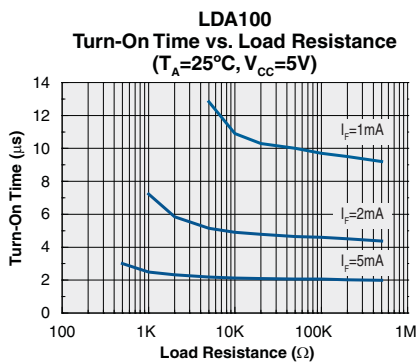
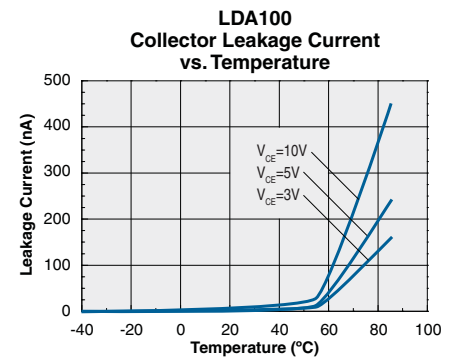
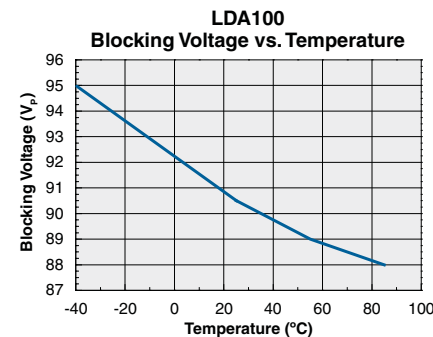
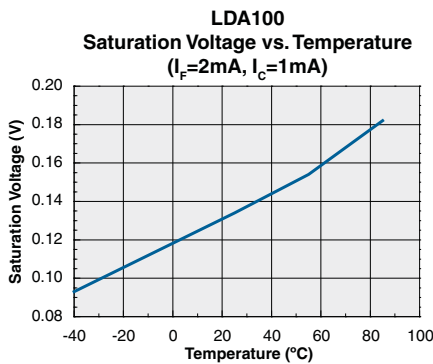
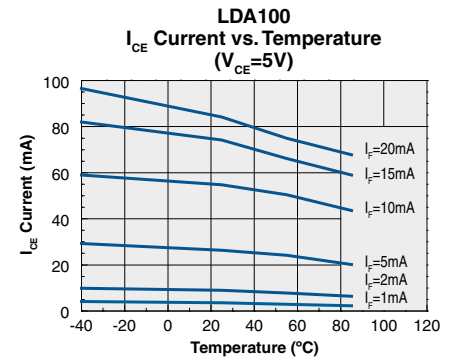
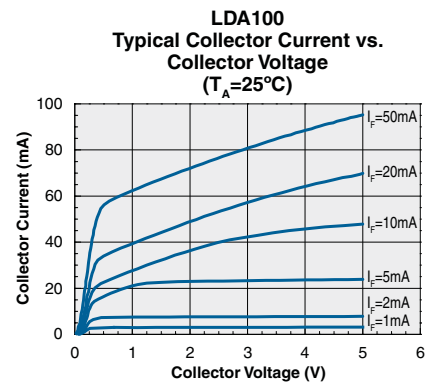
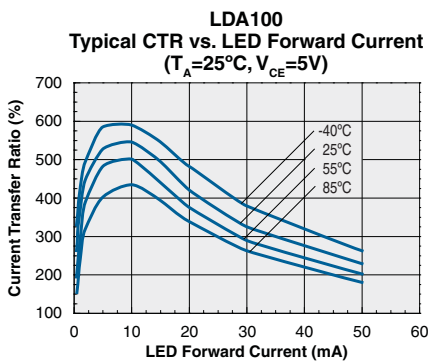
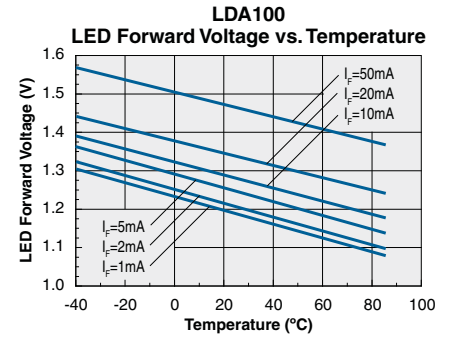
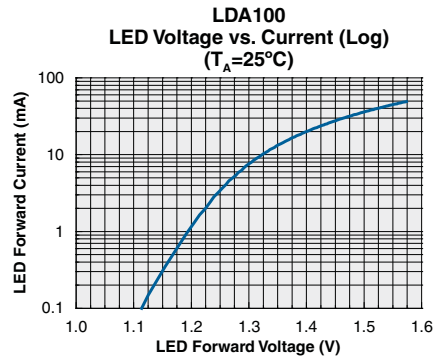
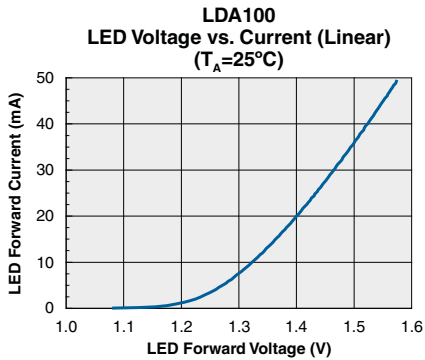

*The Performance data shown in the graphs above is typical of device performance. For guaranteed parameters not indicated in the written specifications, please contact our application department.

Manufacturing Information

Soldering

For proper assembly, the component must be processed in accordance with the current revision of IPC/JEDEC standard J-STD-020. Failure to follow the recommended guidelines may cause permanent damage to the device resulting in impaired performance and/or a reduced lifetime expectancy.

Washing

Clare does not recommend ultrasonic cleaning or the use of chlorinated solvents.



MECHANICAL DIMENSIONS

6-Pin DIP Thru-Hole Package

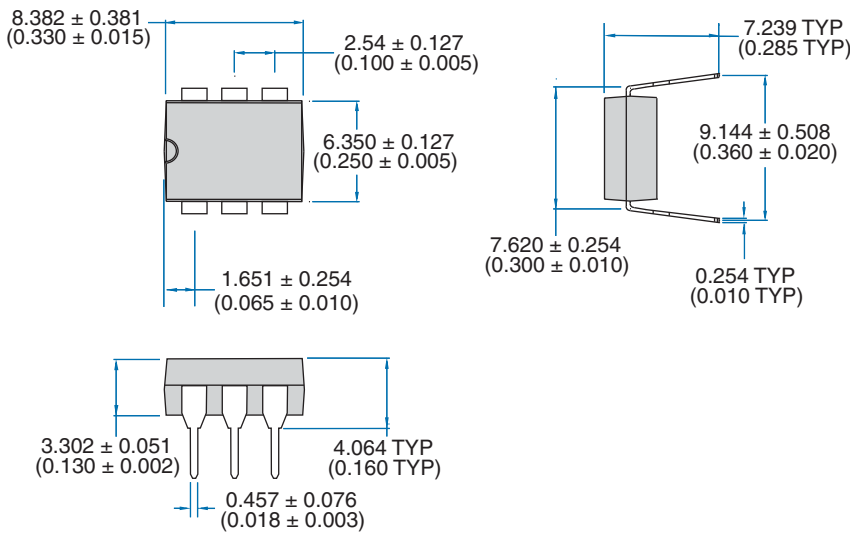

PC Board Pattern

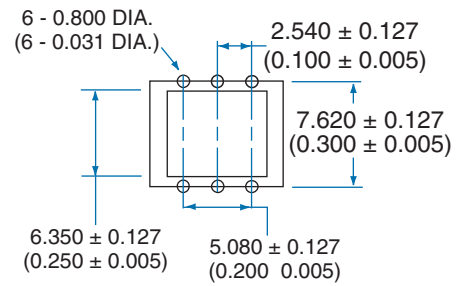

Dimensions
mm
(inches)

6-Pin Surface Mount Package ("S" Suffix)

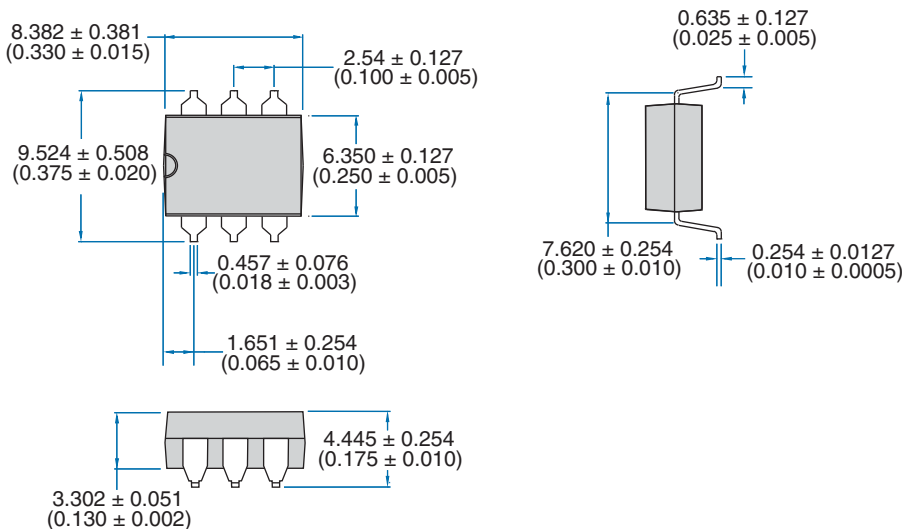

Recommended PCB Land Pattern

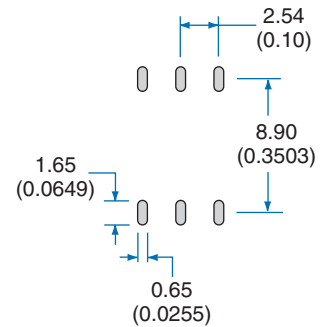

Dimensions
mm
(inches)

Tape and Reel Packaging for 6-Pin “S” Suffix Parts

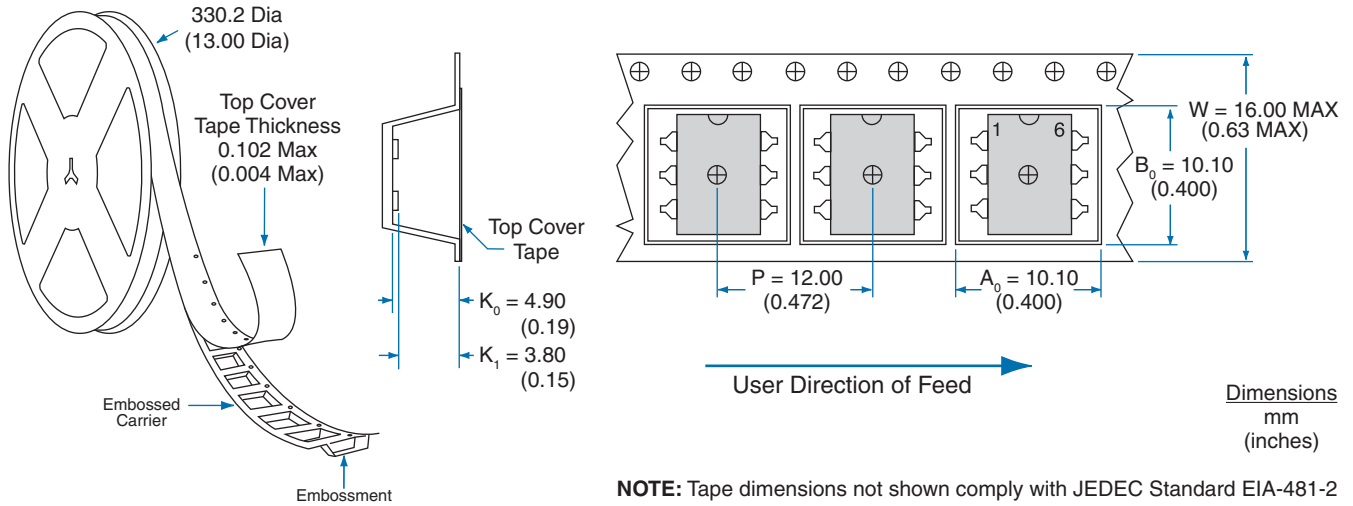

For additional information please visit our website at: www.clare.com

Clare, Inc. makes no representations or warranties with respect to the accuracy or completeness of the contents of this publication and reserves the right to make changes to specifications and product descriptions at any time without notice. Neither circuit patent licenses nor indemnity are expressed or implied. Except as set forth in Clare's Standard Terms and Conditions of Sale, Clare, Inc. assumes no liability whatsoever, and disclaims any express or implied warranty, relating to its products including, but not limited to, the implied warranty of merchantability, fitness for a particular purpose, or infringement of any intellectual property right.

The products described in this document are not designed, intended, authorized or warranted for use as components in systems intended for surgical implant into the body, or in other applications intended to support or sustain life, or where malfunction of Clare's product may result in direct physical harm, injury, or death to a person or severe property or environmental damage. Clare, Inc. reserves the right to discontinue or make changes to its products at any time without notice.